

Rotary Nozzles

Long/Short

Rotary Nozzles - Long



RoHS 10

Type	Material	Heat Resistance Temp.
SPNZL	Body: SUS304 Nozzle: A2017 Bearing: Retaining Ring	60°C

Features

Are Rotary Nozzles - Long Type - intended to blow the air while rotating. The internal bearing rotates by the moment force generated by compressed air. More powerful air blow is possible by rotating.

Tip Shape A (Narrow Angle)

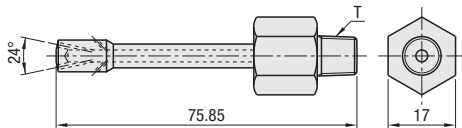

B (Wide Angle)

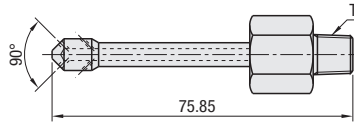

C (Side)

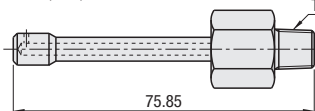

D (Wide Angle + Side)

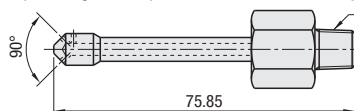

Type	Part Number		Orifice	T	Weight (g)	Unit Price 1 ~ 4 pc(s).	Volume Discount Rate		
	Tip Shape						5-9	10-19	20-30
SPNZL	A (Narrow Angle)	B (Wide Angle)	3-Ø1.2, 2-Ø0.8	R1/8	31				
	C (Side)		3-Ø1.2						
	D (Wide Angle + Side)		6-Ø1.2						

For A and B Types, two Ø0.8 holes are provided to maintain rotation.

For orders larger than indicated quantity, please check with WOS.

Ordering Example: Part Number - Tip Shape
SPNZL - A

Rotary Nozzles - Short



RoHS 10

Type	Material	Heat Resistance Temp.
SPNZ	Body: SUS304 Nozzle: A2017 Bearing: Retaining Ring	60°C

Features

Are Rotary Nozzles - Short Type - intended to blow the air while rotating. The internal bearing rotates by the moment force generated by compressed air. More powerful air blow is possible by rotating.

Tip Shape A (Narrow Angle)

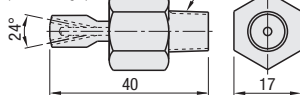

B (Wide Angle)

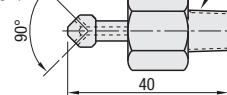

C (Side)

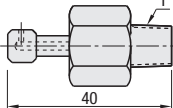

D (Wide Angle + Side)

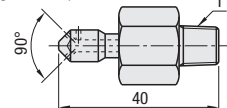

Type	Part Number		Orifice	T	Weight (g)	Unit Price 1 ~ 4 pc(s).	Volume Discount Rate		
	Tip Shape						5-9	10-19	20-30
SPNZ	A (Narrow Angle)	B (Wide Angle)	3-Ø1.2	R1/8	28				
	C (Side)		6-Ø1.2						
	D (Wide Angle + Side)								

For orders larger than indicated quantity, please check with WOS.

Ordering Example: Part Number - Tip Shape
SPNZ - A

SPNZL Air Flow Rate Property Table

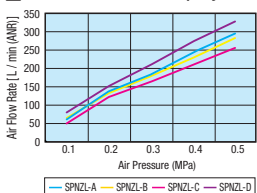

SPNZL Quietness Property Table (Spray Pressure 0.3MPa)

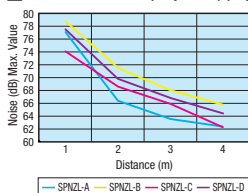

SPNZ Air Flow Rate Property Table

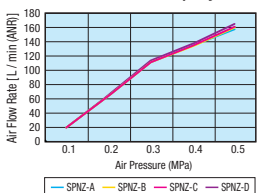

SPNZ Quietness Property Table (Spray Pressure 0.3MPa)

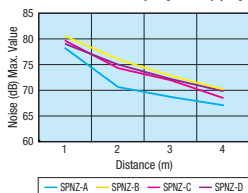

Example

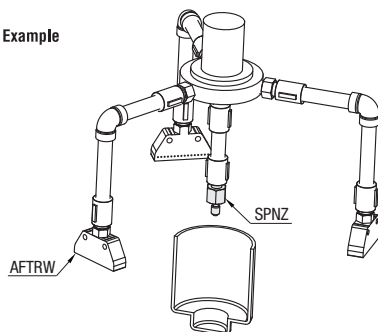

(Cleaning of Cylindrical Workpiece I.D./O.D.)

Values on the graph are for reference, not guaranteed.